

Load bank system modification for appropriatediesel generator testing by programmable resistive load

Marko Rosić and Miroslav Bjekić

University of Kragujevac, Faculty of Technical Sciences Čačak, Serbia

E-mail address: marko.rosic@ftn.kg.ac.rs, miroslav.bjekic@ftn.kg.ac.rs

Abstract—The paper presents adaptation of a commercial AC load bank system modified to deliver controlled load to the diesel generators in order to prevent generator wet-stacking. The described solution involves increasing the existing load resolution from 6*53 kW to a resolution of 56 steps with 5.7 kW, making an approximate total load of 319 kW. The load can be controlled in steps of ± 5.7 kW, ± 17 kW, and ± 51 kW. Measurement of electrical quantities was realized with PM51100 power meter. For the purpose of recording electrical quantities, a low-price solution with a RecMod2021 device using Modbus communication protocol was developed. The RecMod2021 device is programmed to read the PM51100 registers and log read quantities to the belonging SD card. The format of the recorded electrical quantities was adapted for later graphical representation and analysis of the power supply quality, as well as the stability of the generator automatic voltage regulation (AVR) system under various load scenarios.

Keywords- load bank; mobile generators; wet-stacking; programable load; PM5110; data logging, Arduino.

I. INTRODUCTION

The current global energy crisis and the surge in electricity prices have caused the mobile power generator market to witness an unprecedented rise in sales. The fear of power outages in the future has resulted in an unexpected demand for diesel-powered portable generators. Consequently, manufacturers have increased their production of mobile generators to cater to this growing demand. These portable power sources provide a reliable backup energy solution for both residential and commercial customers. They are suitable for various applications, including emergency situations, events, and construction sites. The rising popularity of mobile generators can be attributed to their versatility, portability, and ability to provide reliable power when traditional sources fail.

To ensure optimal performance and long lifetime of diesel generators, regular maintenance is crucial. In addition, the generator's operating regime can also impact its state of health. Extended periods of running at no or light loads can cause "wet stacking," a buildup of thick, dark liquid that can drip from the exhaust system and impair the generator's operation. Therefore, it's important to monitor the operating conditions of diesel generators to prevent this issue and ensure their reliable operation. Wet stacking, depicted in Fig. 1, occurs when unburned fuel, carbon particles, and accumulated moisture gather around the exhaust system components. This may happen for various reasons, but is often caused by running the engine at light loads for a prolonged period of time, resulting in incomplete combustion of the diesel fuel [1].

In order for a diesel engine to run at maximum efficiency, it has to maintain an exact air-to-fuel ratio just like all other internal combustion engines. It also has to maintain a designated operational temperature to have a complete fuel burn. However, when the diesel engine is operated on light or no load, it does not attain the designated operating temperature. Operating below the designated operating temperature as well as allowing the generator to stay unused for long periods of time is what results in wet stacking which inevitable leads to following issues:

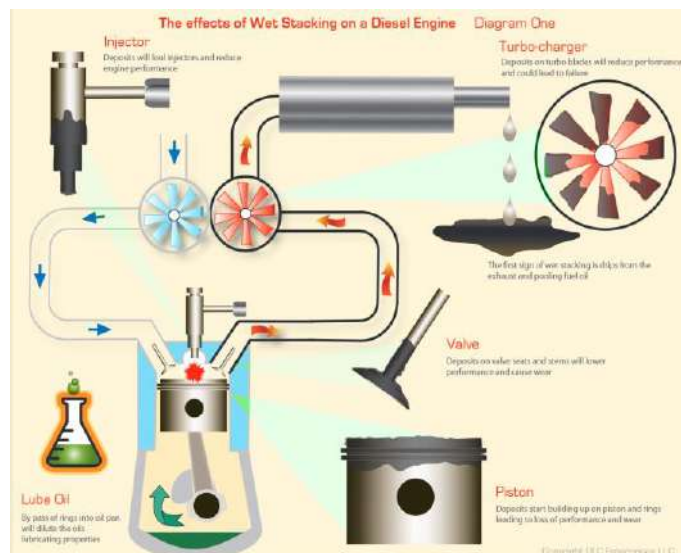

Figure 1. Damage and loss of performance from Wet-stacking [2]

- Expense: Excessive wet stacking shortens the life of engine, resulting in premature (and costly) replacement.
- Pollution: Many urban areas limit smoke emission levels which are produced by wet stacking.
- Power: The carbon deposits that occur because of wet stacking affect the engine's maximum power rating. An engine affected by wet stacking will operate at a lower power than it was designed to achieve.
- Maintenance: An engine affected by wet stacking will require much more maintenance than one that is appropriately exercised.

Due to its harmful effects, wet stacking is being recognized by the organizations that write codes for standby generator set systems, such as the National Fire Protection Association (NFPA) and others. They require maintaining the exhaust temperature at a certain limit and generator loaded by not less than 30% of its name plate. Rather than exercising diesel generator with a light or no load at all, it is recommended that operators run their generators for a few hours at least 75% load in order to avoid wet stacking. Operating generator at this load allows the engine to reach the appropriate temperature needed to effectively burn the fuel entering system.

One of the most common solutions in wet stacking prevention are load bank systems. These systems serve as an appropriate parallel resistive load of the generators forcing them to work close to the rated operating point subsequently reaching rated temperature of the generator. This paper presents an adaptation of a commercial load bank system with integrated possibilities to appropriately load and test diesel generators. The modified solution is able to deliver programmable load to the generator with small load steps, as well to monitor and record basic electrical quantities during the generator examination and testing. The price of the modern accompanying equipment able to provide measurement of basic electrical quantities is directly proportional to its accuracy, data processing, visualisation and recording capabilities. In that sense, the concept of developing a cost-effective solution for measuring electrical power quantities with satisfactory accuracy and recording possibilities is presented in this paper as well. Developed and integrated RecMod2021 logging device is capable to collect data measured with PM5110 power meter through Modbus communication and store it to an SD memory card. Afterwards, these data are used for graphical representation and generator operation analysis which is properly described at the end of the paper. After the graphical representation of the recorded electrical quantities the system allows generation of a report with all numerical and graphical results of the performed test.

II. AC LOAD BANK SYSTEMS

A practical solution that can fit any design is to provide a permanent resistive load bank with self-control based on the exhaust temperature on the connected load and engage its different stages according to the requirement until either the required exhaust temperature is reached or the generator is loaded up to the minimum loading level. The load bank solution remains applicable in some cases if used temporarily during a regular maintenance procedure, where it is considered as a general cure for wet stacking to load generators - based on

its type 85% for standby and prime rated, and up to 100% for continuous rated – up to 4 hours after every 100 hours of low load operation (30 or 40%) [3], [4].

In most cases, load bank systems work in parallel with regular load. Depending on the current consumption or the generator operation temperature, load bank system monitors and apply additional load, if necessary, with the aim to load diesel generator at least 60–80% and keeps it running with optimal temperature necessary to deal with wet stacking. As load elements, usually finned or fin strip tubular heating elements are used inside the load bank (Fig. 2). Parallel connection of these heating elements is controlled by an integrated controller, usually PLC, which control appropriate resistive load to the generator. PLC can be programmed to monitor actual load and consequently rise its load with a goal to reach defined percentage of the rated load (at least 75%).

III. ADAPTATION OF HILLSTONE LOAD BANK SYSTEM

A. The original Hillstone load bank system characteristics

The 3 phase Hillstone load bank [5] with overall capacity of 319 kW at 230V AC per phase is shown in Fig. 3. Inside of this load bank makes 24 air finned single phase heating elements evenly distributed inside with following characteristics:

- 18 big heating elements (5600 W at 230V), and
- 6 small heating elements (950 W at 230V).

During the operation, the heat generated by these heating elements is transferred to the surrounding ambient with forced air convection provided by the integrated fan of 1.5 kW located at the front of the load bank.



Figure 2. Air finned and fin strip tubular heating elements types (on the up-left) and examples of the air heating load bank system (up-right and down)



Figure 3. Hillstone load bank 3 phase AC, 400V, 319 kW

Load control of this Hillstone load bank was realized with *Millenium 3* PLC with relay outputs controlling 6 contactors. Each of these 6 contactors was turning on/off set of heating elements (3 big and 1 small heating elements per phase) with overall power of 53 kW at 400V as can be seen in Fig. 4. Thus, the load could be changed in 6 steps, 6 x 53 kW.

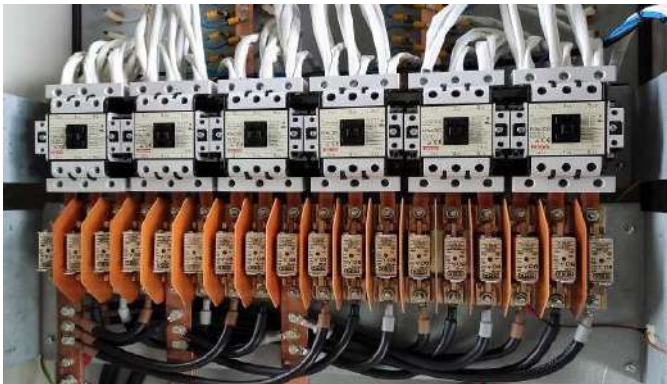

Figure 4. Main 6 contactors with connected set of heating elements

The main lack of the described load bank system is that the load could be only controlled in steps of 53 kW making this load bank unsuited for generators with rated power less than 100kW. Additionally, the controller was programmed to monitor current load of diesel generator and automatically introduce additional load with ± 53 kW on order to reach defined percentage of the load bank full load.

B. Realised modifications on the Hillstone load bank load set

The modification criteria for the existing Hillstone load bank system defined by customer was as follows:

- Enable load control in steps smaller than 53kW, which would allow for testing of low power generators under more precise load control;
- Enable monitoring of actual load in terms of corresponding electrical power supply quantities (active, reactive and apparent power, line and phase voltages, currents, power factor, frequency, THD);
- Enable time-stamped recording of electrical power supply quantities and their appropriate graphical representation for subsequent analysis.

The first part of the modification task required the disconnection of all heating elements and their reorganized configuration. To achieve smaller load steps, the heating elements were reorganized as follows:

- **5.7 kW** (3ph*950W*2) – 1 contactor connected to 2 heating elements of 950 W per phase.
- **11.4 kW** (3ph*950W*4) – 1 contactor connected to 4 heating elements of 950 W per phase.
- **17 kW** (3ph*5600W*1) – 1 contactor connected to 1 heating elements of 5600 W per phase.
- **34 kW** (3ph*5600W*2) – 1 contactor connected to 2 heating elements of 5600 W per phase.
- **51 kW** (3ph*5600W*3) – 5 contactors, each of them connected to 3 heating elements of 5600 W per phase.

Three additional contactors responsible for three new load values were added (as shown in Fig. 5). These contactors are responsible for newly defined load rates of 5.7 kW, 11.4 kW, and 17 kW. One of the remaining 6 contactors is connected to a 34 kW heating element set, while the other 5 contactors are connected to a 51 kW heating element set. Introduced reorganization of the heating elements utilising all 9 contactors allows for 56 load steps with 5.7 kW, resulting in a total capacity of 319 kW of the load bank.

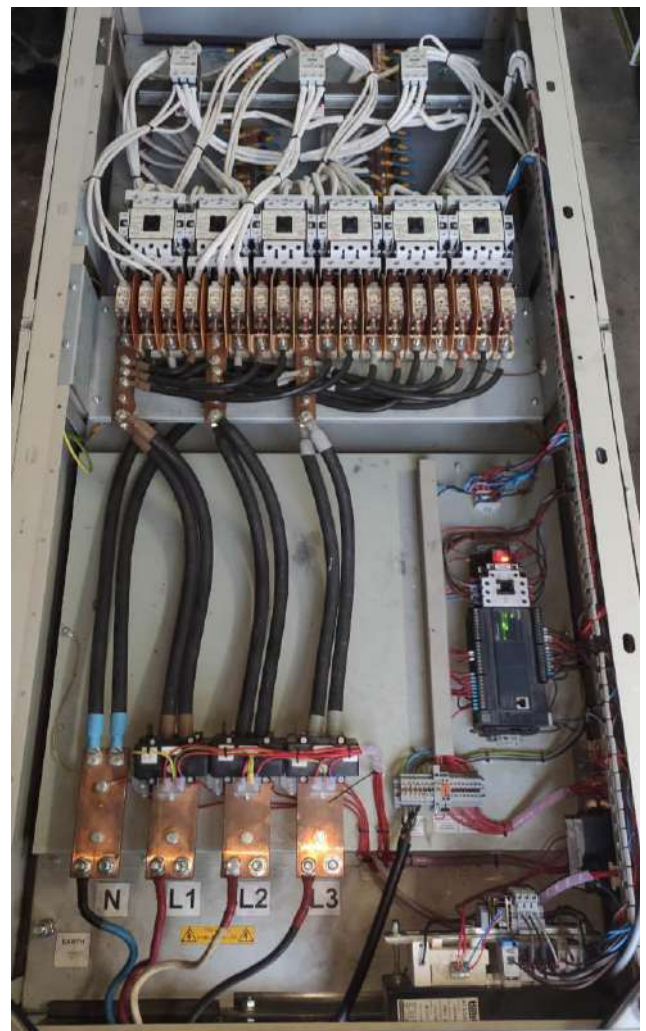

Figure 5. Added contactors for smaller load step at the top, phase busses with installed current transformers, PLC, circuit breakers and other protection.

C. Load control, monitoring and recording

The load control using 9 contactors, is realised using the TM221C40R Modicon M221 PLC with relay outputs. The control panel has 6 push buttons that allow the operator to increase or decrease the generator load in small, medium, and large steps of 5.7 kW, 17 kW, and 51 kW, respectively (as shown in Fig. 6). This allows for more precise control of the generator load, with any load up to 319 kW being set with a resolution of 5.7 kW. In cases where high power generators need to be tested or the generator's response and automatic voltage regulation (AVR) stability at large load steps need to be examined, there are also push buttons with ± 17 kW and ± 51 kW load steps available. In this case, a high load step, for instance $2 \times 51 = 102$ kW, can be set by pressing two times +51 kW button consecutively. The relay outputs of the M221 PLC are programmed to minimize the number of switching operations required to reach the set power. A 0.2 s deadtime is

added between two successive push button operations to avoid imperfect contact operation. Block structure of modified Hillstone load bank is shown in Fig. 7.



Figure 6. Control panel with power meter PM5110 series.

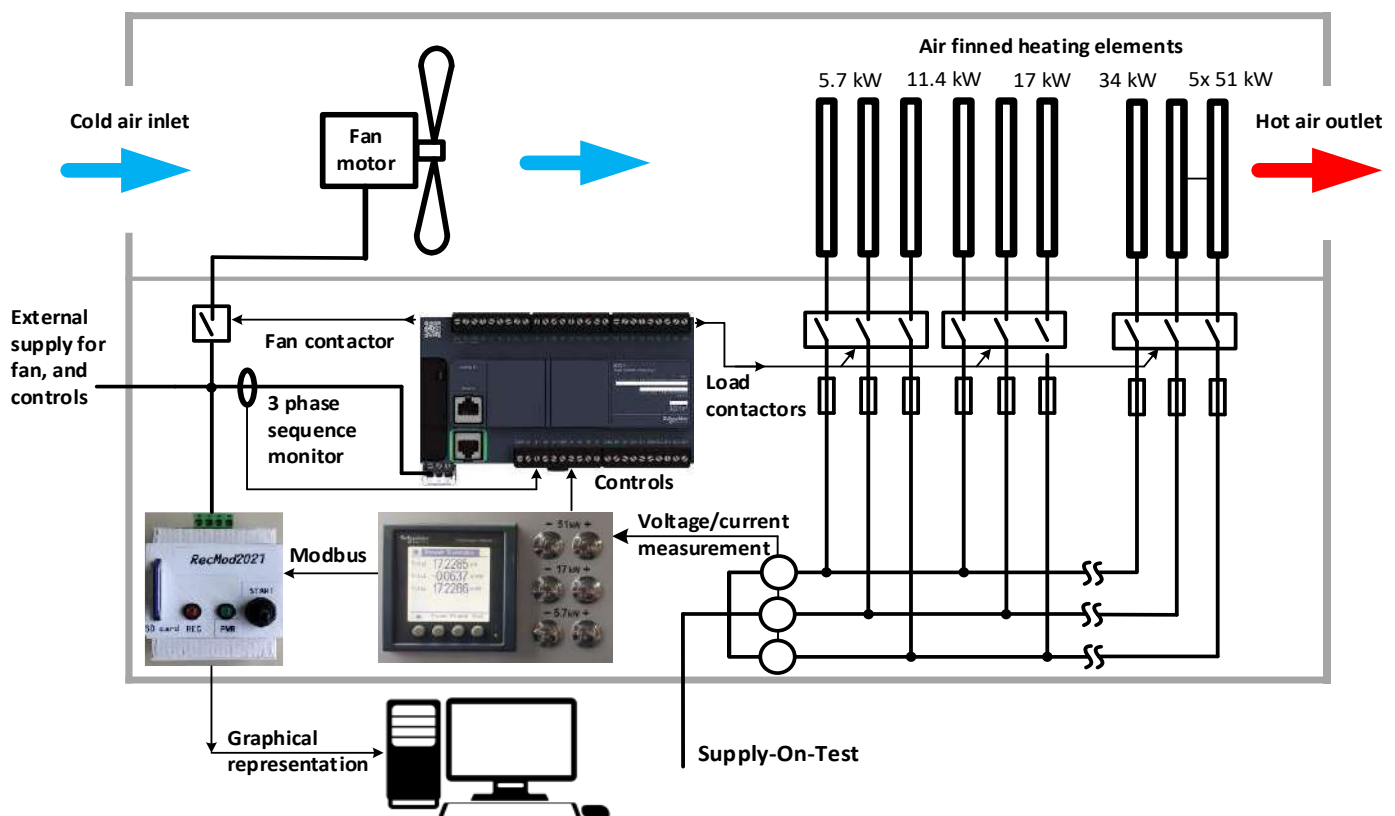

Figure 7. Block structure of the modified Hillstone load bank

Monitoring of electrical quantities during the load test is ensured by 3 busbar current transformers 500/5 A, installed on each phase busbar (as shown in Fig. 8.), and the PM5110 series power meter. The PM5100 provides Class 0.5S accuracy per IEC 62053-22 standard and 64 samples per cycle. The PM5100 will measure Energy, Active and Reactive Power, Voltage, Current, Frequency, Power Factor up to 15th harmonics and is capable of monitoring all three power components, power factor, energy, voltages, currents, frequency, and THD up to the 15th harmonics [6]. The PM5110 has Modbus RTU and ASCII 2 communication protocols with RS485 port support, which are used to read and save the electrical quantities measured by the PM5110.

A specially designed RecMod2021 logging device has been developed for the purpose of logging values measured with PM5100 [7]. The RecMod2021 logging device, shown in Fig. 8 and Fig 10., is based on an Arduino Nano board and an ATmega168 microprocessor. This 8-bit RISC microcontroller contains 16KB of FLASH memory for program storage, as well as 1KB of RAM and 512B of EEPROM memory for data storage. Using the RS485 module, the microcontroller connects with the PM5110 panel meter as a Modbus master [8]. Data is received and saved on an SD memory card, which is linked to a microcontroller through the SPI protocol. Fig. 9 depicts a simplified structural design of a realized RecMod2021 logging device.



Figure 8. Installed RecMod2021 device in operation

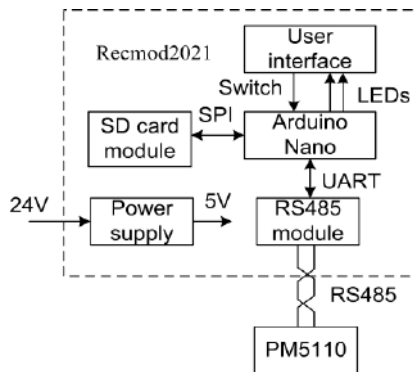

Figure 9. Structural diagram of RecMod2021 device

The UART port is set to communicate in the 8N1 data format at a baud rate of 19200 bps. The PM5110 slave address is set to 1, and the real-time clock registers of the PM5110 slave are read to determine device presence. The SD card is then initialized, and a new CSV file with the predetermined header is created. The CSV file is named Data_XYZ.csv, where XYZ is the log file's decimal number, which is saved in EEPROM and is increased with each new logging file. Data logging begins when the user engages the recording switch (switch START in Fig.10), which appends PM5110 data to a CSV file on a regular basis. The shortest acquisition period is currently set to one second due to the slow communication speed over the RS485 line, but it can be configured to a different value. During each acquisition interval, the microcontroller initially reads the real-time clock registers, followed by the number of measurement registers from the PM5110 slave, and finally appends the obtained data to the CSV file. Table I provides a list of the measurement parameters that are obtained from the PM5110 slave. These parameters are acquired using five Modbus telegrams [9], which read multiple holding registers, starting from the base register address and continuing to the consecutive number of registers [10]. The real-time clock values are read in an unsigned integer format, while the electrical values are obtained in 32-bit floating-point format. The RecMod2021 logging device housing is 3D printed using ABS filament that is suitable for mounting on a DIN rail. The designed 3D model is depicted in Fig. 10 at the top.

TABLE I. LIST OF PM5110 PARAMETERS READ

Parameter	Register base address	Registers read
Real-time clock	1837	7
Currents	3000	12
Voltages	3020	18
Powers (PQS)	3054	32
Frequency	3110	2

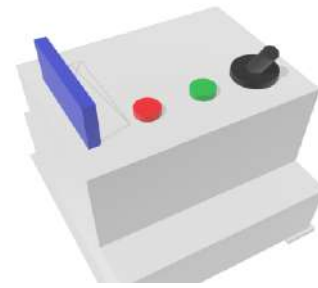

Figure 10. 3D model (top) and final look of the developed RecMod2021 device - ver. 1 (bottom)

The realized device photographs are shown in Fig. 10 displays the initially developed version of the RecMod2021 device with the SD card inserted. Two LEDs are visible next to the START switch on the right-hand side of the device, indicating the presence of power supply (green) and the ongoing recording process (red). When the recording switch is deactivated by the user, the current logging file is closed, and the file number is incremented in EEPROM, which enables the new recording to be appended to a new CSV file. During successful data logging onto the SD card, the recording LED remains continuously on. However, if there is a communication error (such as absence of the SD card or other R/W problems) when the recording starts, the rec. LED will blink rapidly.

IV. GRAPHICAL REEPRESENTATION AND ANALYSIS OF THE RECORDED ELECTRICAL QUANTITIES

After the performed recordings, SD card can be removed and appropriate CSV file can be copied to PC and plotted. Although, saved electrical quantities can be plotted in various application that uses CSV for the graphical representation, the CVS pattern of stored data in this case is adjusted for display using the original ALoadView software. After the software is started, main options related to the testing results are available, such as import of the new results together with the overview of previously recorded measurements as it is shown in Fig 11.

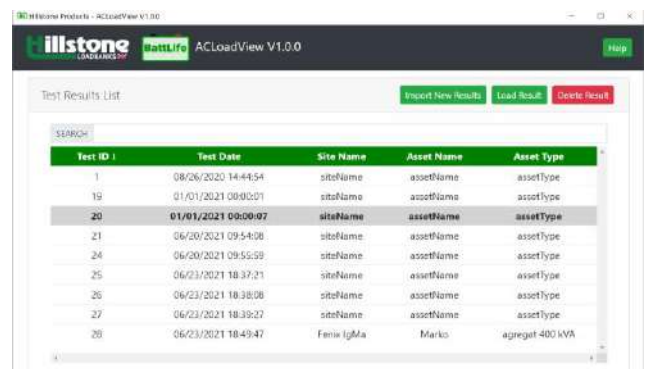

Figure 11. Import of the new testing results in ALoadView software

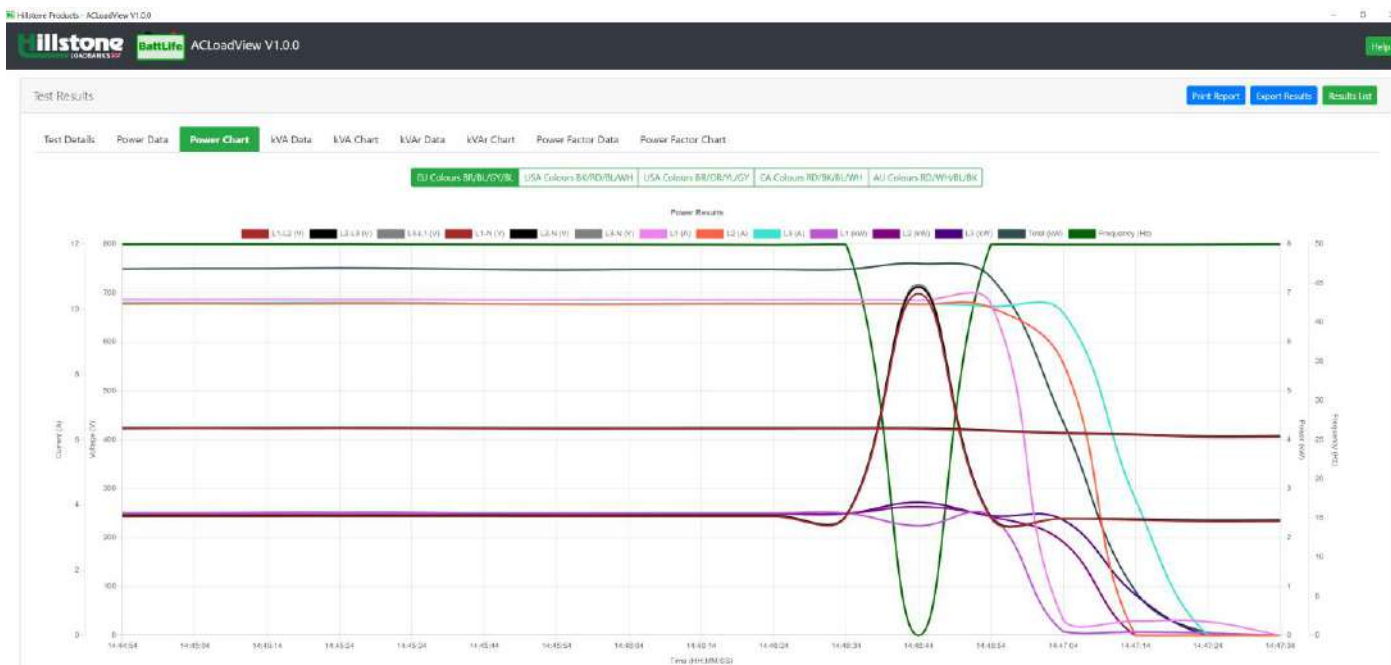

Figure 12. Graphical representation of the results measured with PM5110 and RecMod2021 device

Fig. 12 displays the time evolution of various electrical quantities, recorded with RecMod21 device after the *Power Chart* tab is selected. Each of the recorded electrical quantity can be selected, and shown/hidden by choosing the corresponding colour on the top of the graph. This feature allows for quick and simple analysis of the Automatic Voltage Regulation (AVR) system response to sudden load changes and identification of potential generator malfunctions. During the generator load test all three power components, power factor, and generator frequency could be plotted enabling examination of their interdependence.

Fig. 13 shows the results of testing diesel generator of 200 kW rated power on the step load change. Several load steps of 51 kW and 17 kW are applied during the test after which sudden unloading of the generator is enforced. The

results of recorded line voltage, phase current, total power and frequency depicted in Fig. 13 shows high degree of robustness and well performances (in terms of variations and drops of the measured values) of the generator AVR system during the test.

On the other hand, the results of tested generator of 11kW shows unstable operation of its AVR system in operation point close to generator rated power. Fig. 14. shows a large drop in line voltage (from 380 V to 330 V) and frequency (50-44 Hz) in case where the second load step of 5.7 kW is applied. Whether the poor generator performances are the results of wet-stacking problem or potential inappropriate operation of the corresponding AVR system, the presented system allows user to perceive the problem, and subsequently confirm generator operation characteristics after the problem is removed by going through another testing procedure.

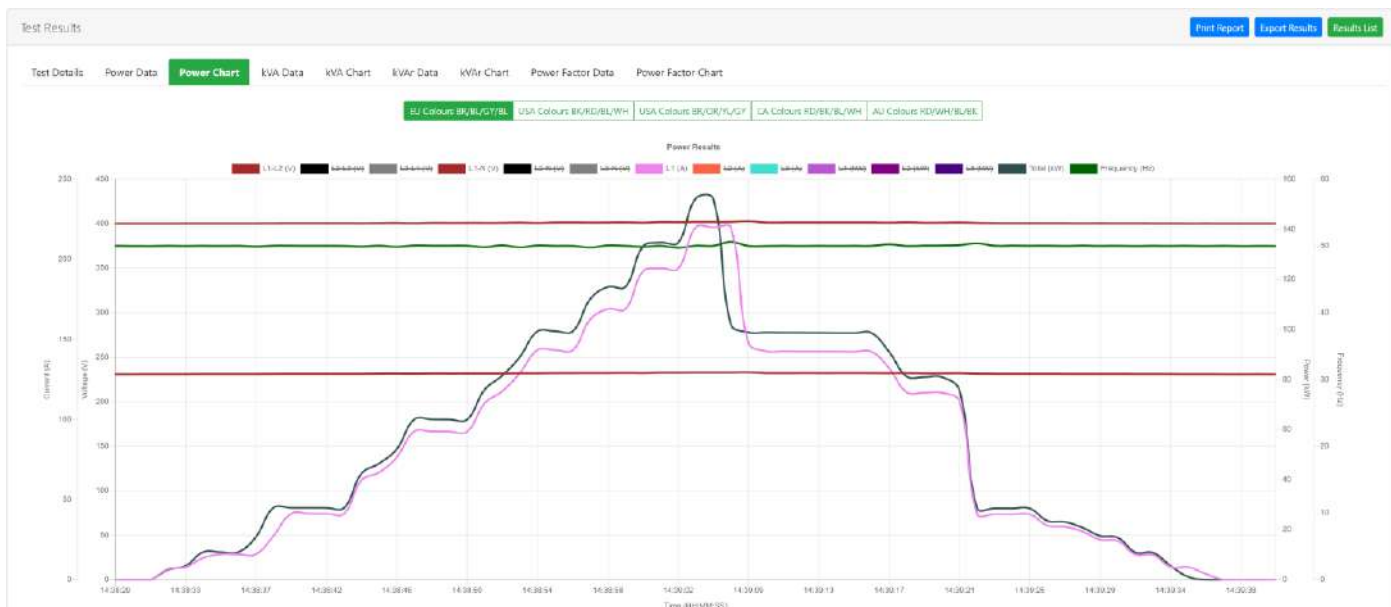

Figure 13. The results of tested diesel generator of 200 kW

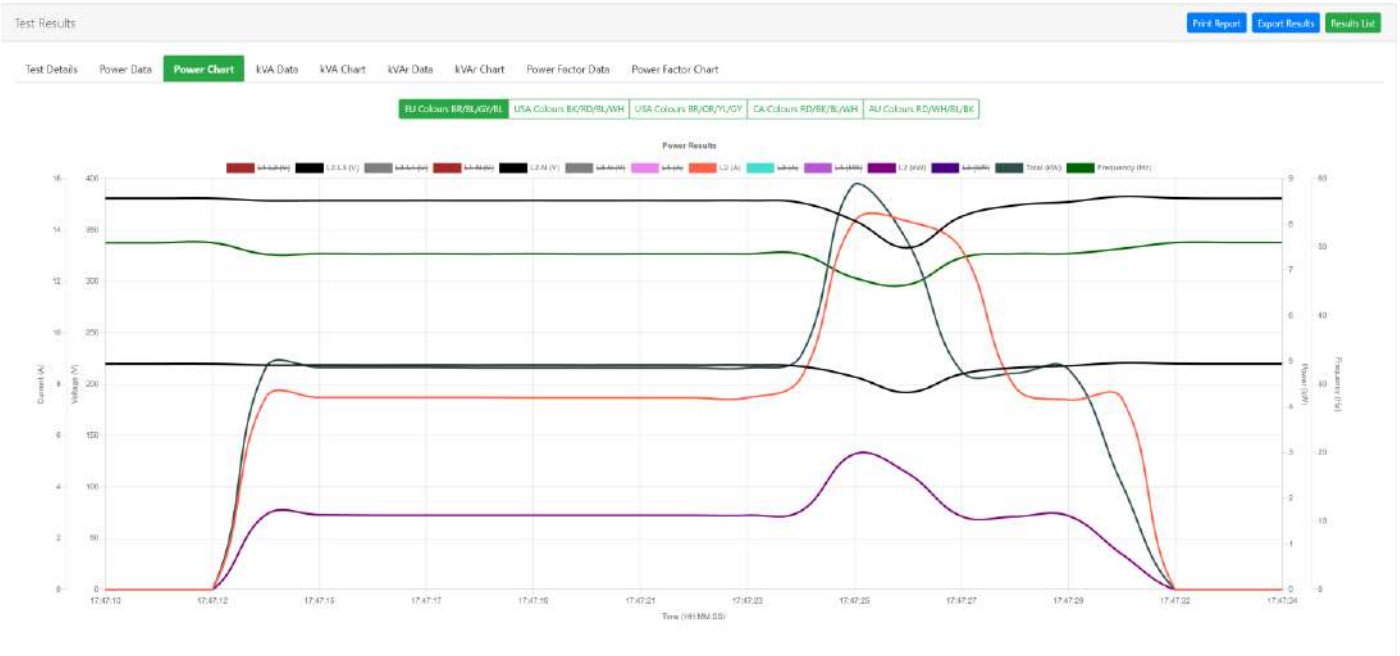

Figure 14. The results of tested diesel generator of 11 kW

After the graphical representation and analysis of the testing results, the ACLoadView software allows printing out different categories of reports with basic test details and numerical and graphical test results, in the form of a PDF document (Fig. 15, Fig. 16). The generated PDF report can be printed and joined with the accompanying generator's documentation, as a proof of the tested generator's performances under various load and on-site testing conditions.

V. SUMMARY

The paper presents modifications of the commercially available load bank with the aim of increasing the resolution of the applied load and recording characteristic electrical quantities with the ability of their graphical representation. The original six levels of 53 kW load have been replaced with 56 new levels of 5.7 kW. In addition to ± 5.7 kW, load control is enabled in increments of ± 17 kW and ± 51 kW by simply selecting the appropriate pushbutton. The measurement of electrical quantities is carried out with the PM 5110 power meter, while recording is performed with the RecMod2021 device. The RecMod0221 device is specifically designed to allow data to be written to an SD card in a format adapted for graphical display in the ACLoadView software. The implemented system allows for simpler and more accurate control of the generator load with the ability to record and analyse characteristic electrical quantities. The possibility of graphical representation (of the recorded electrical quantities during the test) enables further analysis of the delivered power quality and overall AVR stability at different levels of load as well as the identification of potential malfunctions. After the preformed load test, it is possible to generate a PDF report with the test results in order to confirm the diesel generator health and performances. The price of the proposed system is at least twice as inexpensive in comparison to other commercially available alternatives when compared to the identical system potentials and features.

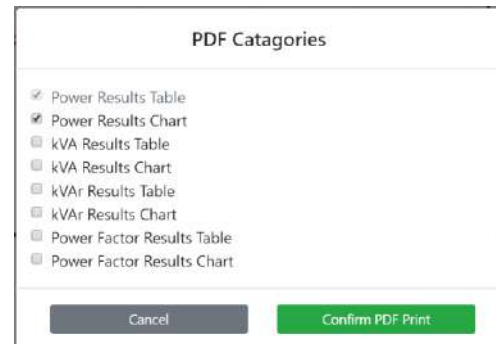

Figure 15. Selection of desired type of the PDF report in ACLoadView



Figure 16. Generated test report pages

ACKNOWLEDGEMENT

This study was supported by the Ministry of Science, Technological Development and Innovations of the Republic of Serbia, and these results are parts of the Grant No. 451-03-47/2023-01/200132 with University of Kragujevac - Faculty of Technical Sciences Čačak.

REFERENCES

- [1] Eric A. Arevalo, "Wet-Stacking", Electrical Generating Systems Association, Available online jan. 2023: <https://www.powercity.ph/wp-content/uploads/2015/12/Wet-Stacking-v2.pdf>
- [2] Absolute generators – Dealing with Wet Stacking, Available online jan. 2023: <https://www.absolutegenerators.com/blog/Dealing-Wet-Stacking/>
- [3] Dany Maalouf, "Wet Stacking effects on diesel engine & prevention", Available onl. jan. 2023: https://www.slideshare.net/EdaratGroup/wet-stacking-effects?from_action=save
- [4] Multiquip – Technical information, Diesel engine wet-stacking prevention, online available: https://service.multiquip.com/pdfs/Diesel_Engine_Wet_Stacking_Prevention.pdf
- [5] Hillstone load banks, Available online jan. 2023, <https://hillstone.co.uk/>
- [6] PM5110 metter data sheet, Available online jan. 2023: <https://www.se.com/ww/en/product/METSEPM5110/pm5110-meter-modbus-up-to-15th-h-1do-33-alarms/>
- [7] Rosić M., Pesović U., "Graphical representation of basic electrical power quantities measured with power logic PM5000 series", *Proceedings of International Scientific Conference UNITECH '22*, Vol. I, pp. 98-102, Gabrovo, Bulgaria, 18-19. November 2022
- [8] Modicon inc, Modbus Protocol Reference Guide, June 1996, Available online: oct. 2022, https://modbus.org/docs/PI_MBUS_300.pdf
- [9] MODBUS Organization, MODBUS over Serial Line Specification & Implementation guide V1.0, 2002, Available online: oct. 2022, https://modbus.org/docs/Modbus_over_serial_line_V1.pdf
- [10] PM5100_PM5300 Register List v01.00.0, Available online: oct. 2022, https://www.se.com/ww/en/download/document/PM5100-PM5300_PublicRegisterList/



Marko Rosić received the BSc and MSc degrees in electrical engineering from the Faculty of Technical Sciences Čačak, the University of Kragujevac in 2008, and the PhD degree from the School of Electrical Engineering, the University of Belgrade in 2016. Since 2008 he has been with the Department of Power Engineering, Faculty of Technical Sciences Čačak, University of Kragujevac, currently as an Associate

Professor. He is author or co-author of more than 70 journal and conference papers. His research interests include electrical machines and drives, power electronics, and control of electrical drives.



Miroslav Bjekić graduated from the Technical Faculty Čačak (1991), he received his magistrate degree from the University of Belgrade, Department of Electrical Engineering (1996), and his PhD degree from the Technical Faculty Čačak (2006). His field of research includes electric micro machines, simulation, and modelling of electromechanical processes. He is co-author of two university textbooks, author of two handbooks for electric machines laboratory exercises, three

computer handbooks, and didactic handbook for engineering teachers. He has created six original educational computer software.